

TOP HINGE DETAIL

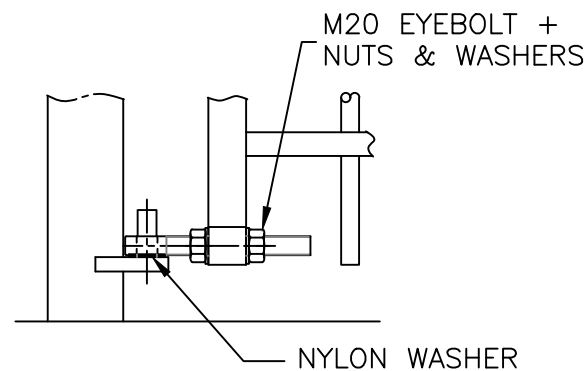

BOTTOM HINGE DETAIL
(SCALE 1:8)

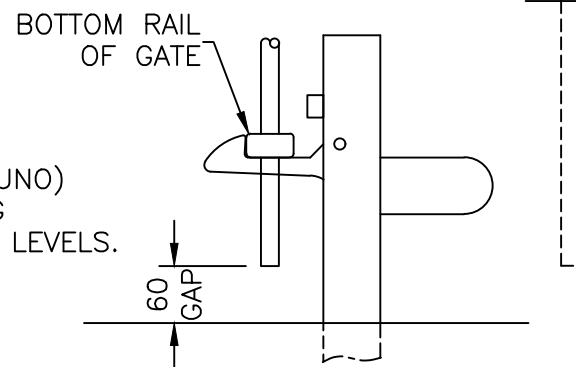

HOLD BACK LATCH POST
(SCALE 1:8)

NOTES.

ALL DIMENSIONS ARE IN mm (UNO)
GAPS UNDER GATES & FENCING ARE NOMINAL DUE TO GROUND LEVELS.

MATERIALS.

HANG POST: SEE TABLE
RAILS: 50 x 25 RHS
STILES: 60 x 40 RHS
PALES: ø19 CHS

FINISH.

GALVANISED TO BS EN ISO 1461
POWDER COATED: IF REQUESTED

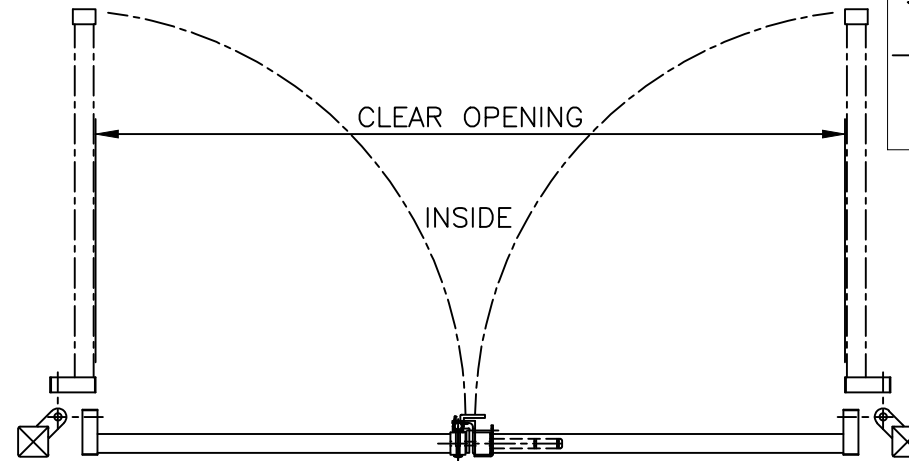

GATES SECURED USING DROPBOLT & PADLOCKABLE SLIDE LATCH

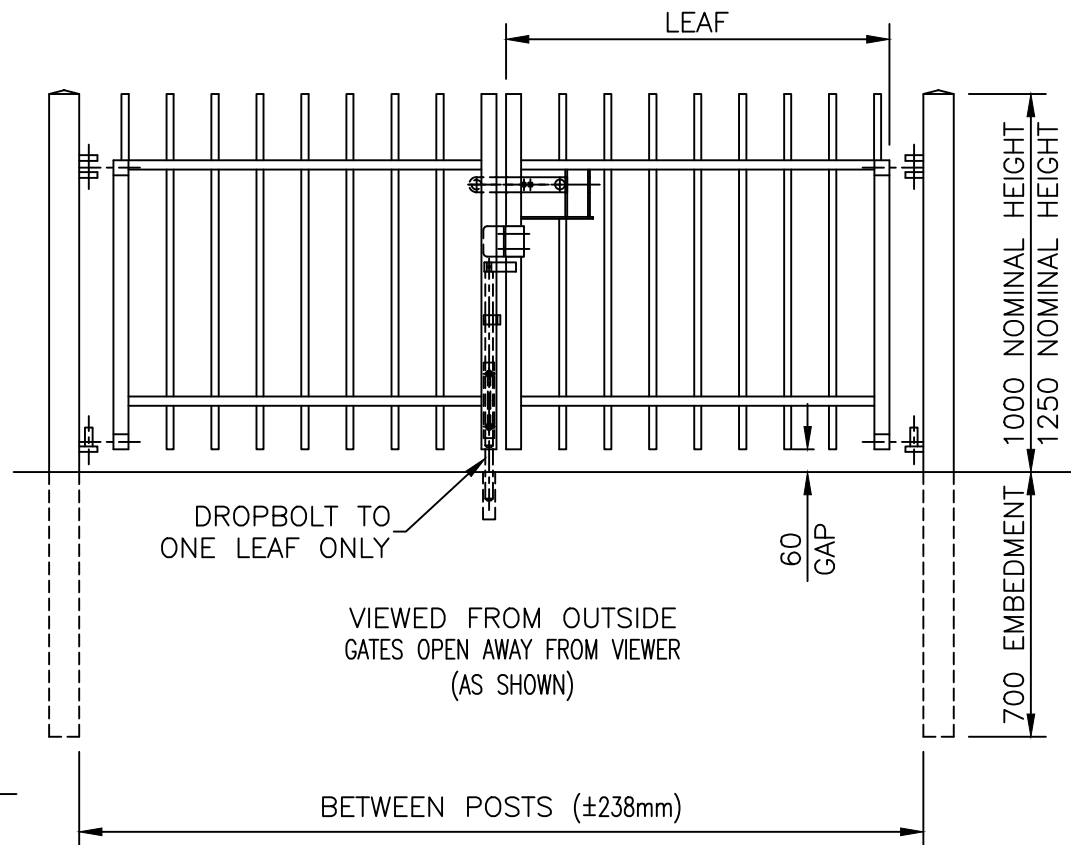

1m & 1.25m STANDARD FENCE HEIGHTS

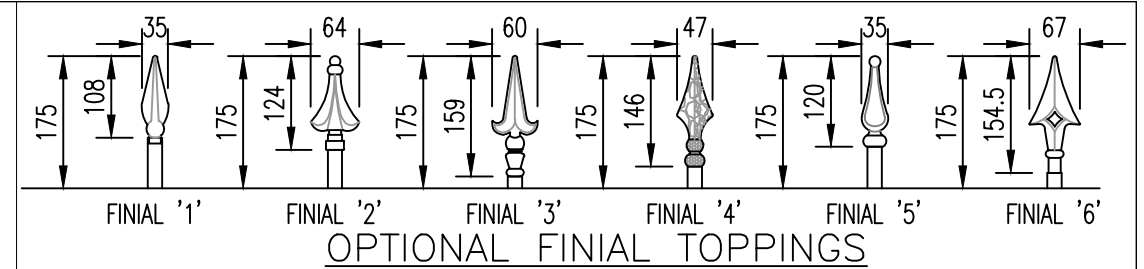

DOUBLE GATES (SLIDE LATCH)			
BETWEEN POSTS	CLEAR OPENING	LEAF	POST SIZE
1995	1745	895	80 x 80 SHS
2233	1983	1014	80 x 80 SHS
2471	2221	1133	80 x 80 SHS
2709	2459	1252	80 x 80 SHS
2947	2697	1371	80 x 80 SHS
3185	2935	1490	80 x 80 SHS
3423	3173	1609	100 x 100 SHS
3661	3411	1728	100 x 100 SHS
3899	3649	1847	100 x 100 SHS
4137	3887	1966	100 x 100 SHS
4375	4125	2085	100 x 100 SHS
4613	4363	2204	100 x 100 SHS

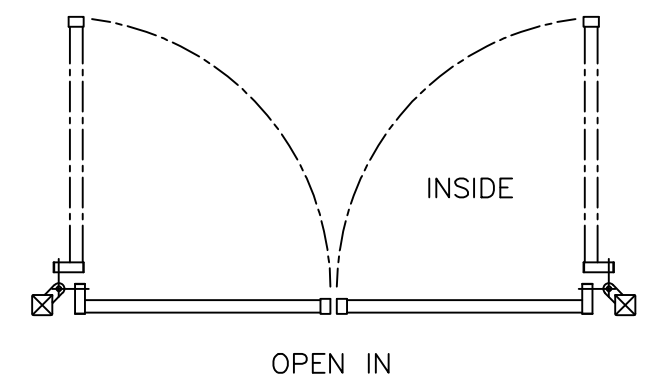
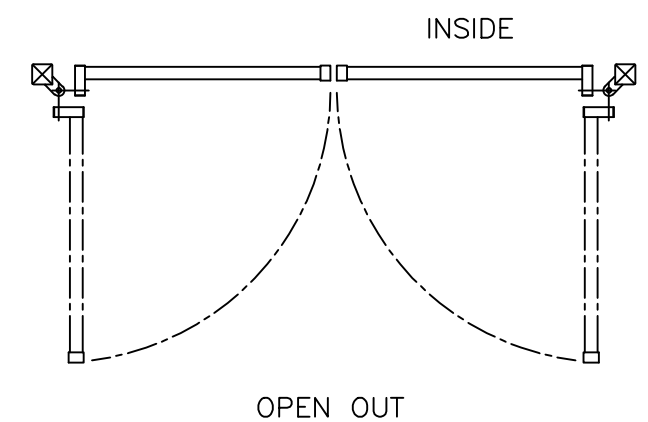

Stowting Common, Near Ashford, Kent. TN25 6BN
Telephone: 01233 750393
Fax: 01233 750403
www.jacksons-fencing.co.uk
www.jacksons-security.co.uk

DO NOT SCALE – IF IN DOUBT ASK

2 17/05/2018 UPDATED & CORRECTED
1 06/11/17 SHROUD DETAIL ADDED
0 31/05/2017 Original Issue

Drawn NM
Date 31/05/2017
Checked CJ
Size A3 Scale 1:20 U.O.S

TITLE IMPERIAL 'RESIDENTIAL' DOUBLE GATES SALES DRAWING (SLIDE LATCH)

CUSTOMER
ACK No.

Drawing No.
J1/02157
Sheet 3

This Drawing Is The Property Of H.S. Jackson & Son (Fencing) Ltd, And May Not Be Copied Or Reproduced In Any Way Without Prior Written Permission.